

TECHNICAL INFORMATION

EASYSLIDE



Information in this document is subject to change. Owing to continued product development, Rollco reserves the right to make alterations without prior notice. Every care has been taken to ensure the accuracy of the information, but no liability can be accepted for any errors or omissions.

All information and content included in this document, such as text, and images, are property of Rollco. Any reproduction, even partial, is allowed only by written permission by Rollco.

Index

GENERAL INFORMATION	4
Product overview	4
TECHNICAL INFORMATION	6
Static load	6
Service life	7
Application coefficient f_i	8
Clearance and preload	8
Coefficient of friction	8
Linear accuracy	8
Speed	8
Temperature	9
Anticorrosive protection	9
Lubrication	9
Fixing screws	9
INSTALLATION INSTRUCTIONS	10
Instructions for use	10
ORDER CODE	11
SN Version 1 with 1 slider	11
SN Version 2 with Multiple Independent Sliders	12
SN Version 3 with Multiple Synchronized Sliders	13

Product overview

Easyslide is a compact and strong linear rail system with long service life. The system consists of a C-shaped linear profile rail with single, double or synchronised sliders with caged ball bearings. The linear rails are manufactured from drawn steel and has hardened internal raceways, which allows high loads and vibrations. Different stroke variations with the same installation dimensions are possible.

Rollco Easyslide is available in three different versions.

SN linear bearing with single slider - version 1

This linear bearing consists of a guide rail and a slider that runs within the ball cage in the guide rail. High load capacities, compact cross-sections and simple and easy mounting characterize this series. In our product range we only list standard lengths and strokes of version 1. Special strokes and lengths on request.

SN linear bearing with multiple independant sliders - version 2

Variant with several sliders, which each runs in its own ball cage, independent of each other in the guide rail. Can be configured and used in an almost infinite variety of ways. The most common is to make a symmetrical configuration. Contact Rollco for further advice.

SN linear bearing with multiple synchronized sliders - version 3

Several sliders run in a common ball cage within the guide rails. The division of the inner slider in two parts have a positive influence on load capacity and running behavior under high M_z and M_y loads. Contact Rollco for detailed advice and calculations.



Characteristics

- Available sizes: 22, 28, 35, 43, 63
- Inductive hardened raceways
- Rails and sliders made of cold-drawn bearing steel
- Balls made of hardened bearing steel
- Ball cage made of steel
- Max. operating speed 0.8 m/s
- Temperature range: -30 °C to +170 °C
- Electrolytic zinc-plating as per ISO 2081; increased anticorrosive protection on request

Application areas

- Transportation industry (e.g. exterior and interior rail and bus doors, seat adjustments, interior)
- Construction and machine technology (e.g. housings, protective covers)
- Medical technology (e.g. X-ray equipment, medical tables)
- Automotive technology
- Logistics (e.g. handling units)
- Packaging machines (e.g. beverage industry)
- Special machines

Remarks

- For horizontal installation only.
- External stops are recommended.
- Fixing screws of property class 10.9 must be used for all linear bearings.

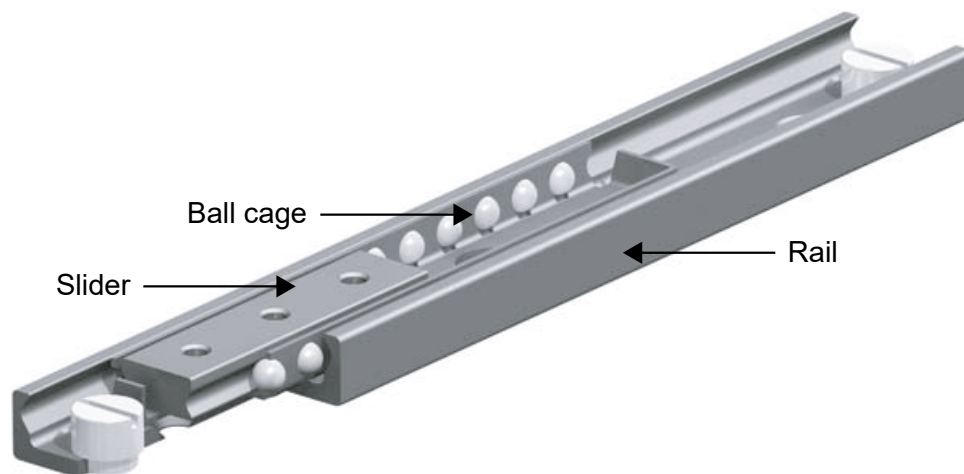

Static load

The maximum static loads of the SN series are defined using the slider length and are listed in the tables of the previous pages. These load capacities are valid for a loading point of forces and moments in the center of the slider. The load capacities are independent of the position of the slider inside the rails. During the static tests the radial load capacity, C_{Orad} , the axial load capacity, C_{Oax} , and moments M_x , M_y and M_z indicate the maximum permissible values of the loads. Higher loads negatively affect the running properties and the mechanical strength. A safety factor, S_o , is used to check the static load, which takes into account the basic parameters of the application and is defined in more detail in the following table:

Safety factor S_o

Neither shocks nor vibrations, smooth and low-frequency reverse, high assembly accuracy, no elastic deformations	1 - 1.5
Normal installation conditions	1.5 - 2
Shocks and vibrations, high frequency reverse, significant elastic deformation	2 - 3.5

The ratio of the actual load to maximum permissible load may be as large as the reciprocal of the accepted safety factor, S_o , at the most.

$$\frac{P_{Orad}}{C_{Orad}} \leq \frac{1}{S_o} \quad \frac{P_{Oax}}{C_{Oax}} \leq \frac{1}{S_o} \quad \frac{M_1}{M_x} \leq \frac{1}{S_o} \quad \frac{M_2}{M_y} \leq \frac{1}{S_o} \quad \frac{M_3}{M_z} \leq \frac{1}{S_o}$$

The formulas above apply for a single load case. If there are two or more of the described forces simultaneously, the following check must be made:

$$\frac{P_{Orad}}{C_{Orad}} + \frac{P_{Oax}}{C_{Oax}} + \frac{M_1}{M_x} + \frac{M_2}{M_y} + \frac{M_3}{M_z} \leq \frac{1}{S_o}$$

- P_{Orad} = effective radial load
- C_{Orad} = permissible radial load
- P_{Oax} = effective axial load
- C_{Oax} = permissible axial load
- M_1 = effective moment in the x-direction
- M_x = permissible moment in the x-direction
- M_2 = effective moment in the y-direction
- M_y = permissible moment in the y-direction
- M_3 = effective moment in the z-direction
- M_z = permissible moment in the z-direction

Off-center load P of the slider:

For an off-center load of the slider, the different load distribution on the balls must be accounted for with a reduction of the load capacity C. As shown in the diagram below, this reduction of the distance, d, from the loading point is dependent on the slider center. The value, q, is the position factor, the distance, d, is expressed in fractions of slider length S. The permissible load, P, decreases as follows:

$P = q \cdot C_{Orad}$ for a radial load

$P = q \cdot C_{Oax}$ for an axial load

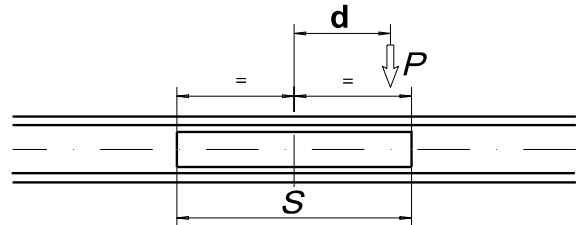

For the static load and the service life calculation, P_{Orad} and P_{Oax} must be replaced by the equivalent values calculated as follows:

$P_{Orad} = \frac{P}{q}$ if the external load P acts radially

$P_{Oax} = \frac{P}{q}$ if the external load P acts axially

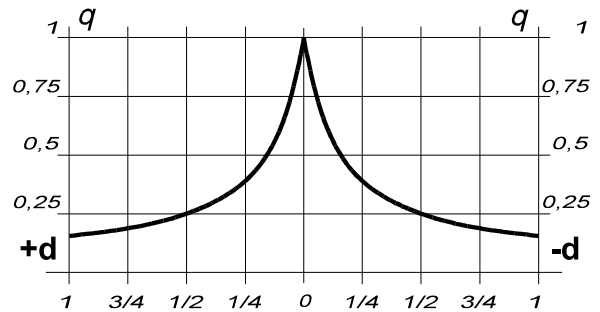

Service life

The service life of a linear bearing depends on several factors, such as effective load, operating speed, installation precision, occurring impacts and vibrations, operating temperature, ambient conditions and lubrication. The service life is defined as the time span between initial operation and the first fatigue or wear indications on the raceways. In practice, the end of the service life must be defined as the time of bearing decommissioning due to its destruction or extreme wear of a component. This is taken into account by an application coefficient (f_i in the formula below), so the service life consists of:

$L_{km} = 100 \cdot \left(\frac{C}{W} \cdot \frac{1}{f_i} \right)^3$

- L_{km} = calculated service life (km)
- C = dynamic load capacity (N) = C_{Orad}
- W = equivalent load (N)
- f_i = application coefficient

The stroke factor f_h takes into account the higher load of the raceways and rollers during short strokes on the same total length of run. The corresponding values are taken from the following graph (for strokes longer than 1 m, f_h = 1):

No. of sliders	1	2	3	4
f _c	1	0.8	0.7	0.63

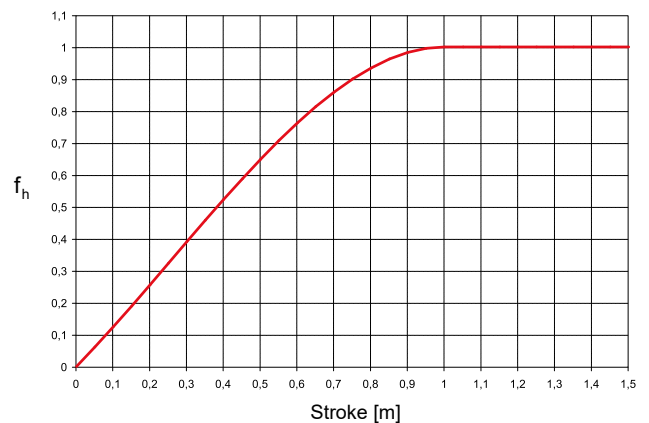

Application coefficient f_i

Neither impacts nor vibrations, smooth and low-frequency direction change, clean operating conditions, low speed (<0.5 m/s)	1 - 1.5
Slight vibrations, average speeds (between 0.5 and 0.7 m/s) and average direction change	1.5 - 2
Impacts and vibrations, high-frequency direction change, high speeds (>0.7 m/s), very dirty environment	2 - 3.5

If the external load, P, is the same as the dynamic load capacity, C_{Orad} , (which of course must never be exceeded), the service life at ideal operating conditions ($f_i = 1$) amounts to 100 km. Naturally, for a single load P, the following applies: $W = P$. If several external loads occur simultaneously, the equivalent load is calculated as follows:

$$W = P_{rad} + \left(\frac{P_{ax}}{C_{Oax}} + \frac{M_1}{M_x} + \frac{M_2}{M_y} + \frac{M_3}{M_z} \right) \cdot C_{Orad}$$

Clearance and preload

The SN series linear bearings are installed with no clearance as standard. For more information, please contact Rollco.

Preload classes		
Increased clearance	No clearance	Increased preload
G_1	Standard	K_1

Coefficient of friction

With correct lubrication and installation on level and rigid surfaces and sufficient parallelism for rail pairs, the friction value is less than or equal to 0.01. This value can vary depending on the installation situation.

Linear accuracy

With installation of the rails using all bolts on a perfectly plane support surface with the fixing holes in a straight line, the linear accuracy of the sliders to an external reference results from the following equation:

$$\parallel = \frac{\sqrt{H}}{300} \text{ (mm)} \quad H = \text{stroke}$$

Speed

The linear bearings of the SN series can be used up to an operating speed of 0.8 m/s (31.5 in/s). With high-frequency direction changes and the resulting high accelerations, as well as with long ball cages, there is a risk of cage creep.

Temperature

The SN series can be used in ambient temperatures from -30 °C to +170 °C (-22 °F to +338 °F). A lithium lubricant for high operating temperatures is recommended for temperatures above +130 °C (+266 °F).

Anticorrosive protection

The SN series has a standard anticorrosive protection by electrolytic zinc-plating according to ISO 2081. If increased anticorrosive protection is required, the rails are available chemically nickel-plated and with stainless steel bearing balls.

Numerous application-specific surface treatments are available upon request, e.g., as a nickel-plated design with FDA approval for use in the food industry. For more information please contact us.

Lubrication

Recommended lubrication intervals are heavily dependent upon the ambient conditions. Under normal conditions, lubrication is recommended after 100 km operational performance or after an operating period of 6 months. In critical application cases the interval should be shorter. Please clean the raceways carefully before lubrication. Raceways and spaces of the ball cage are lubricated with a lithium lubricant of average consistency (roller bearing lubricant).

Different lubricants for special applications are available upon request. Example: Lubricant with FDA approval for use in the food industry. For more information please contact us.

Fixing screws

The rails of the SN series in sizes 22 to 43 mm are fixed with countersunk head screws according to DIN 7991.

Tightening torques of the standard fixing screws to be used.

Property class	Size	Tightening torque (Nm)
10.9	22	4.3
	28	8.5
	35	14.6
	43	34.7
	63	34.7

Screws for size 63:

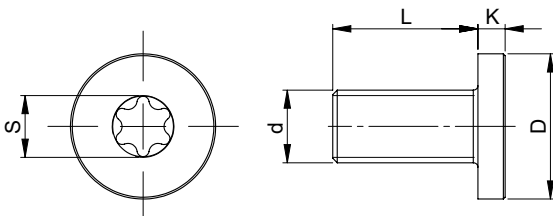

Size	Screw type	d	D	L mm	K	S	Tightening torque
63	M8 x 20	M8 x 1.25	13	20	5	T40	34.7

Installation instructions

Internal stops are used to stop the unloaded slider and the ball cage. Please use external stops as end stops for a loaded system.

To achieve optimum running properties, high service life and rigidity, it is necessary to fix the linear bearings with all accessible holes on a rigid and level surface.

Prepare a sufficient bevel on the threaded fixing holes, according to the following table:

Size	Bevel (mm)
22	0.5 x 45°
28	1 x 45°
35	1 x 45°
43	1 x 45°
63	1 x 45°

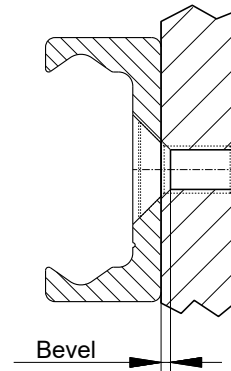

Instructions for use

For linear bearings of the SN series, the sliders are guided through a ball cage inside the rails. When the sliders run their course relative to the rails, the ball cage moves along for half the slider stroke. The stroke ends as soon as the slider reaches the end of the cage.

Normally the cage moves synchronously to the balls at half the speed of the slider. Any occurring cage slip affects the synchronous movement of the ball cage negatively, causing it to reach the internal stops prematurely (cage creep). This reduces the stroke. However, the stroke value can be normalized at any time by moving the slider to the stop in the stopped cage. This moving of the slider relative to the cage will have increased resistance, which is dependent on the working load.

The causes of cage creep can be installation accuracy, dynamics, and load changes. The effects can be minimized by observing the following advice:

- The stroke should always remain constant and come as close as possible to the nominal stroke of the linear bearing.
- For applications with various strokes, make sure that the drive is sufficiently dimensioned to guarantee a movement of the slider relative to the cage. A coefficient of friction of 0.1 should be calculated for this.
- Another possibility is to include a maximum stroke without load in the working cycle in order to resynchronize the slider and ball cage.

Parallelism errors or inaccuracies in the installation or in the mounting surfaces of mounted pairs can influence the cage creep.

Series SN linear bearings should only be used for horizontal movement.

SN Version 1 with 1 slider

SN - 35 - 290 - 430 - 770 - K1 - NIC

Product type	SN	35	290	430	770	K1	NIC
Size							
Slider length							
Stroke							
Rail length							
Clearance and preload (if deviating from standard)							
Expanded surface protection							

Ordering example 1: SN35-290-430-770

Ordering example 2: SN35-290-430-770-K1-NIC

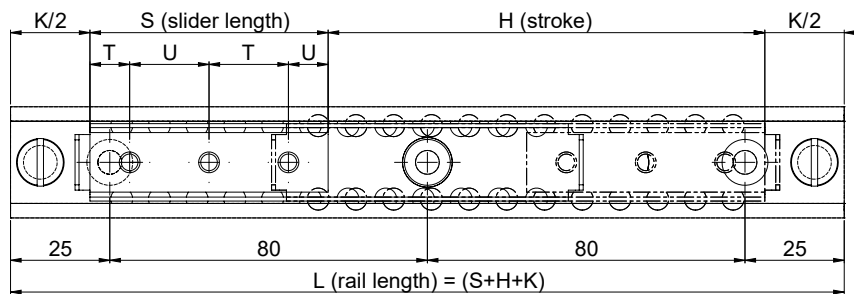

Note: To ensure that all fixing holes of the rail are accessible, S must be $< L/2 - K$. To ensure proper smooth movement it is necessary that $H \leq 7S$

SN Version 2 with Multiple Independent Sliders

	SN - 43 - 2 - 290 - 350 - 1330 - G1 - NIC
Product type	
Size	
Number of sliders	
Slider length	
Stroke of the individual sliders	
Rail length	
Clearance and preload (if deviating from standard)	
Expanded surface protection	

Ordering example 1: SN43-2x290-350-1330

Ordering example 2: SN43-2x290-350-1330-G1-NIC

If the individual slider lengths and/or strokes are different, please order according to ordering example 3.

Ordering example 3: SN28-1x200-300/1x250-415-1240

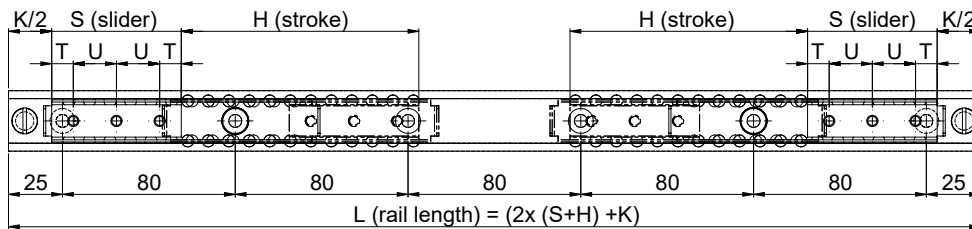

Version 2 is a variant of version 1 with several independent sliders. The total load capacity is based on the number of sliders in the rail and on their lengths.

For systems of versions 2 in size 63 with two independent sliders, the K dimension changes from 80 mm to 110 mm and for each additional slider by another 30 mm.

Note: To ensure that all fixing holes of the rail are accessible, S must be $< L/2 - K$. To ensure proper smooth movement it is necessary that $H \leq 7S$

SN Version 3 with Multiple Synchronized Sliders

SN - 63 - 850 - (370+290) - 400 - 1330 - K1 - NIC

Product type	SN	63	850	(370+290)	400	1330	K1	NIC
Size								
Apparent length, S' of the slider								
Individual length of slider								
Stroke								
Rail length								
Clearance and preload (if deviating from standard)								
Expanded surface protection								

Ordering example 1: SN63-850(370+290)-400-1330

Ordering example 2: SN63-850(370+290)-400-1330-K1-NIC

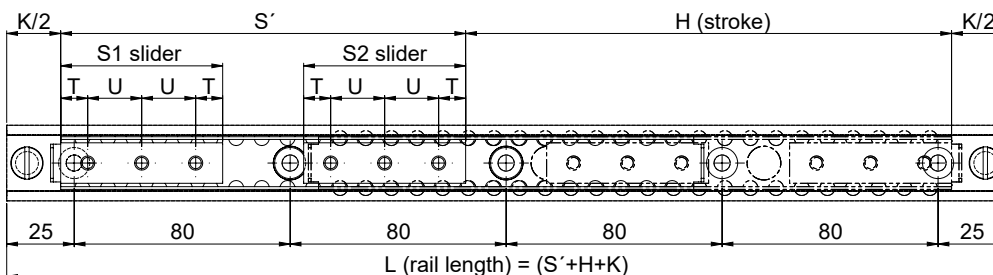

Version 3 is a variant of version 1 with several synchronized sliders. The total load capacity is based on the number of sliders in the rail. The length of the individual sliders can therefore vary.

Note: To ensure that all fixing holes of the rail are accessible, S must be $< L/2 - K$. To ensure proper smooth movement it is necessary that $H \leq 7S$

**ALWAYS THE RIGHT
SOLUTION AT THE RIGHT TIME.**

ROLLCO

LINEAR SOLUTIONS **YOUR WAY**

With reliability, competence and commitment Rollco rapidly delivers the right solutions and components to create safe and cost-effective automation and linear movement.

Rollco AB

Box 22234
Ekvändan 3
250 24 Helsingborg
Sweden
Tel. +46 42 15 00 40
www.rollco.se

Rollco A/S

Skomagervej 13 E
7100 Vejle
Denmark
Tel. +45 75 52 26 66
www.rollco.dk

Rollco Oy

Sarankulmankatu 12
33900 Tampere
Finland
Tel. +358 207 57 97 90
www.rollco.fi

Rollco Norge AS

Industrigata 6
3414 Lierstrada
Norway
Tel. +47 32 84 00 34
www.rollco.no