

EASYSLIDE

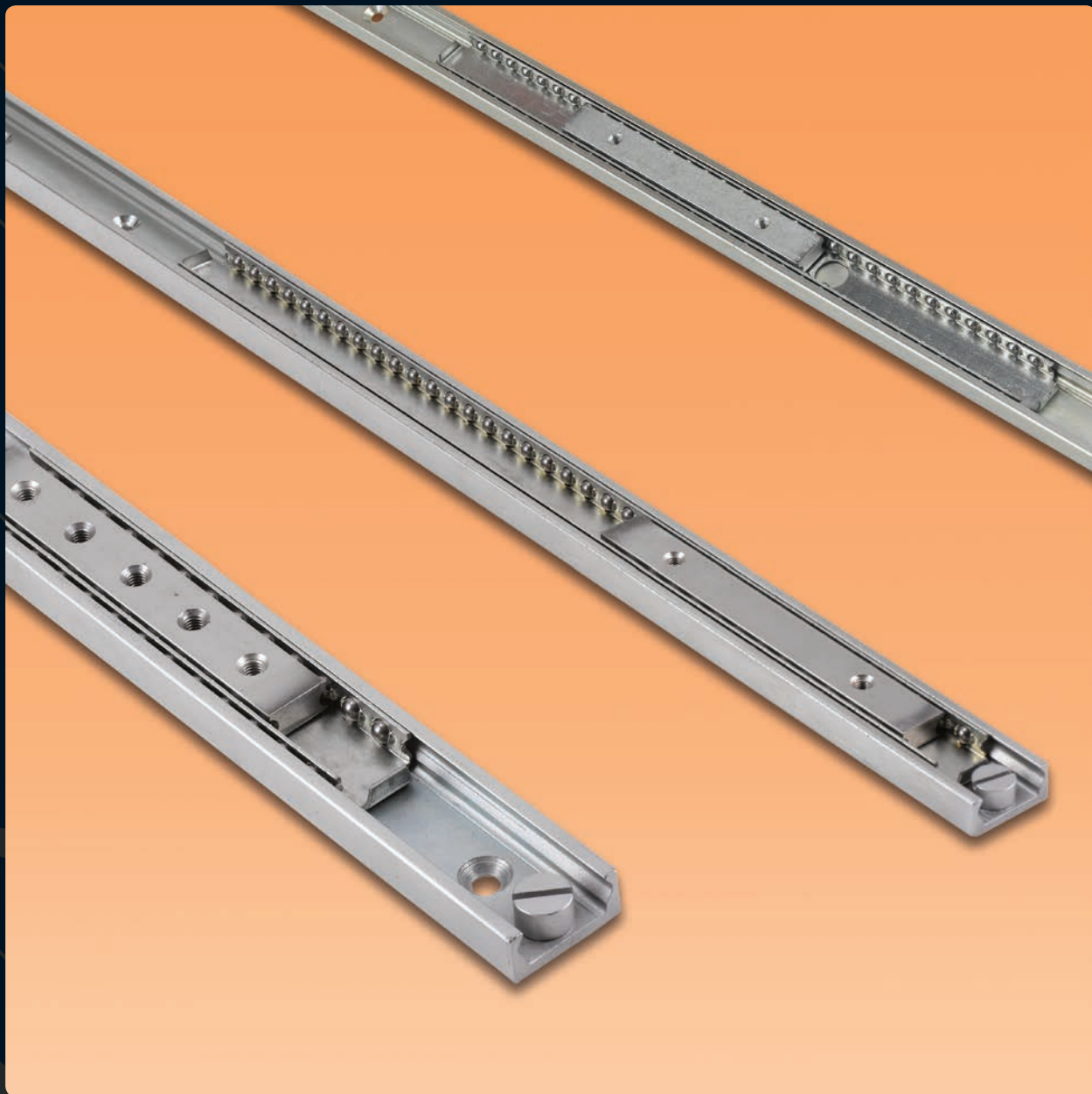

ROLLCO

SPECIALIZED
ON LINEAR MOTION

Every care has been taken to ensure the accuracy of the information contained in this catalogue, but no liability can be accepted for any errors or omissions. We reserve the right to make changes without prior notice.

Any reproduction, even partial, is allowed only by written permission by Rollco.



**CLIMATE
COMPENSATED
PAPER**



Index

PRODUCT OVERVIEW	4
Performance Characteristics	5
Application areas	5
Remarks	5
PRODUCT DIMENSIONS	6
Slider	6
SN Cross-section	7
Rail	7
ORDER CODES	8
SN Version 1 with 1 slider	8
SN Version 2 with Multiple Independent Sliders	9
SN Version 3 with Multiple Synchronized Sliders	10
TECHNICAL INFORMATION	11
Static Load	11
Service Life	12
Clearance and Preload	13
Coefficient of Friction	13
Linear Accuracy	13
Speed	13
Temperature	14
Anticorrosive Protection	14
Lubrication	14
Fixing screws	14
INSTALLATION INSTRUCTIONS	15
Instructions for Use	15
STANDARD CONFIGURATIONS	16

Product Overview

Easyslide is a compact and strong linear rail system with long service life. The system consists of a C-shaped linear profile rail with single, double or synchronised sliders with caged recirculating ball bearings. The linear rails are manufactured from drawn steel and has hardened internal raceways, which allows high loads and vibrations. Different stroke variations with the same installation dimensions are possible.

Rollco Easyslide is available in three different versions.

SN linear bearing with single slider - version 1

This linear bearing consists of a guide rail and a slider that runs within the ball cage in the guide rail. High load capacities, compact cross-sections and simple and easy mounting characterize this series.

SN linear bearing with multiple independant sliders - version 2

Variant with several sliders, which each runs in its own ball cage, independent of each other in the guide rail. Slider length and stroke for each slider can be different within one rail.

SN linear bearing with multiple synchronized sliders - version 3

Several sliders run in a common ball cage within the guide rails. The slider lengths can vary and then form a total unit, which implements the corresponding stroke.



Performance Characteristics

- Available sizes: 22, 28, 35, 43, 63
- Inductive hardened raceways
- Rails and sliders made of cold-drawn bearing steel
- Balls made of hardened bearing steel
- Ball cage made of steel
- Max. operating speed 0.8 m/s
- Temperature range: -30 °C to +170 °C
- Electrolytic zinc-plating as per ISO 2081; increased anticorrosive protection on request

Application areas

- Transportation industry (e.g. exterior and interior rail and bus doors, seat adjustments, interior)
- Construction and machine technology (e.g. housings, protective covers)
- Medical technology (e.g. X-ray equipment, medical tables)
- Automotive technology
- Logistics (e.g. handling units)
- Packaging machines (e.g. beverage industry)
- Special machines

Remarks

- For horizontal installation only.
- External stops are recommended.
- Fixing screws of property class 10.9 must be used for all linear bearings.

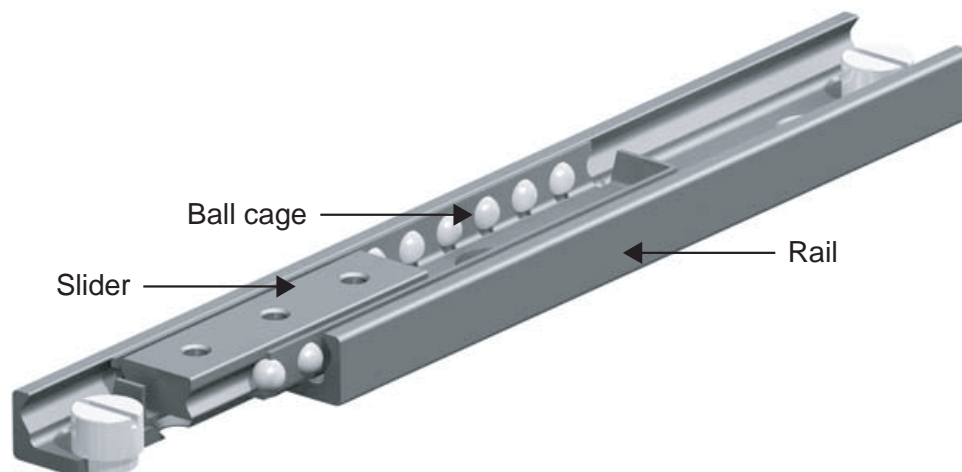

Slider

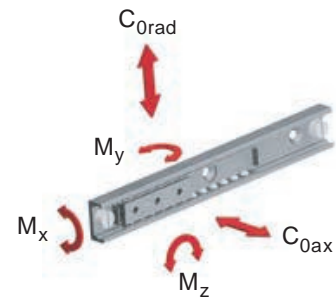

Slider type	Size	Dimensions			No. of holes	Load capacities				
		Length S mm	a mm	b mm		C_{0rad} N	C_{0ax} N	M_x Nm	M_y Nm	M_z Nm
SN	22	40	10	20	2	1320	924	4.4	6	9
		60	10	20	3	1980	1386	6.7	14	20
		80	10	20	4	2640	1848	8.9	25	35
		130	25	80	2	4290	3003	14.4	65	93
		210	25	80	3	6930	4851	23.3	170	243
		290	25	80	4	9570	6699	32.2	324	463
SN	28	60	10	20	3	3480	2436	17.1	24	35
		80	10	20	4	4640	3248	22.7	43	62
		130	25	80	2	7540	5278	36.9	114	163
		210	25	80	3	12180	8526	59.7	298	426
		290	25	80	4	16820	11774	82.4	569	813
		370	25	80	5	21460	15022	105.1	926	1323
SN	35	450	25	80	6	26100	18270	127.9	1370	1958
		130	25	80	2	9750	6825	47.2	148	211
		210	25	80	3	15750	11025	76.3	386	551
		290	25	80	4	21750	15225	105.3	736	1051
		370	25	80	5	27750	19425	134.4	1198	1711
		450	25	80	6	33750	23625	163.4	1772	2531
		530	25	80	7	39750	27825	192.5	2458	3511
SN	43	610	25	80	8	45750	32025	221.6	3256	4651
		130	25	80	2	13910	9737	96	211	301
		210	25	80	3	22470	15729	155.1	551	786
		290	25	80	4	31030	21721	214.1	1050	1500
		370	25	80	5	39590	27713	273.2	1709	2441
		450	25	80	6	48150	33750	332.3	2528	3611
		530	25	80	7	56710	39697	391.4	3507	5009
SN	63	610	25	80	8	65270	45689	450.4	4645	6636
		130	25	80	2	26000	18200	238.8	394	563
		210	25	80	3	42000	29400	385.8	1029	1470
		290	25	80	4	58000	40600	532.8	1962	2803
		370	25	80	5	74000	51800	679.8	3194	4563
		450	25	80	6	90000	63000	826.7	4725	6750
		530	25	80	7	106000	74200	973.7	6554	9363
		610	25	80	8	122000	85400	1120.7	8682	12403

SN Cross-section

SN 22-43

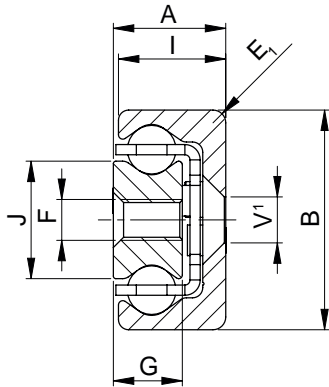

SN 63

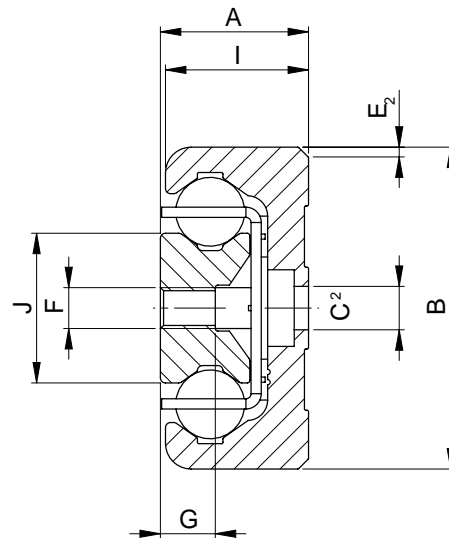

1: Fixing holes (V) for countersunk head screws according to DIN 7991

2: Fixing holes (C) for socket cap screws according to DIN 7984. Alternative fixing with Torx® screws in special design with low head (on request)

Slider type	Size	Cross-section										Rail weight kg/m	Slider weight
		A	B	I	J	G	E1	E2	V	C	F		
		mm											
SN	22	11	22	10.25	11.3	6.5	3	-	M4	-	M4	0.7	1
	28	13	28	12.25	15	7.5	1	-	M5	-	M5	1	1.5
	35	17	35	16	15.8	10	2	-	M6	-	M6	1.8	2.5
	43	22	43	21	23	13.5	2.5	-	M8	-	M8	2.6	5
	63	29	63	28	29.3	10.5	-	2x45	-	M8	M8	6.1	6.9

Rail

Rail type	Size	Length L*	K
		mm	mm
SN	22	130 - 210 - 290 - 370 - 450 - 530 - 610 - 690 - 770 - 850 - 930 - 1010 - 1090 - 1170	30
SN	28	130 - 210 - 290 - 370 - 450 - 530 - 610 - 690 - 770 - 850 - 930 - 1010 - 1090 - 1170 - 1250 - 1330 - 1410 - 1490 - 1570 - 1650	40
SN	35	290 - 370 - 450 - 530 - 610 - 690 - 770 - 850 - 930 - 1010 - 1090 - 1170 - 1250 - 1330 - 1410 - 1490 - 1570 - 1650 - 1730 - 1810	50
SN	43	290 - 370 - 450 - 530 - 610 - 690 - 770 - 850 - 930 - 1010 - 1090 - 1170 - 1250 - 1330 - 1410 - 1490 - 1570 - 1650 - 1730 - 1810 - 1890 - 1970	50
SN	63	610 - 690 - 770 - 850 - 930 - 1010 - 1090 - 1170 - 1250 - 1330 - 1410 - 1490 - 1570 - 1650 - 1730 - 1810 - 1890 - 1970	80

*Standard lengths. Other lengths are available upon request.

SN Version 1 with 1 slider

SN - 35 - 290 - 430 - 770 - K1 - NIC

Product type	
Size	
Slider length	
Stroke	
Rail length	
Clearance and preload (if deviating from standard)	
Expanded surface protection	

Ordering example 1: SN35-290-430-770
 Ordering example 2: SN35-290-430-770-K1-NIC

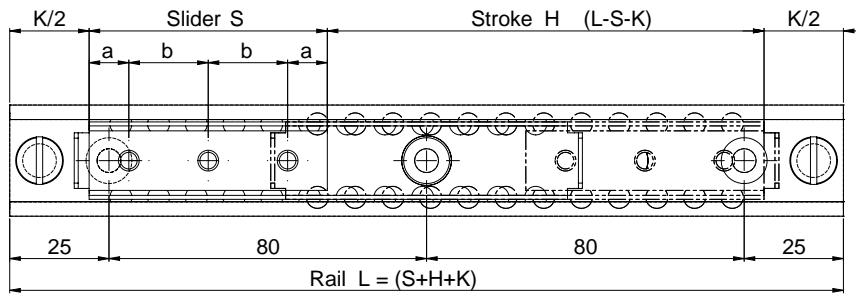

Note: To ensure that all fixing holes of the rail are accessible, S must be $< L/2 - K$. To ensure proper smooth movement it is necessary that $H \leq 7S$

SN Version 2 with Multiple Independent Sliders

SN - 43 - 2 - 290 - 350 - 1330 - G1 - NIC

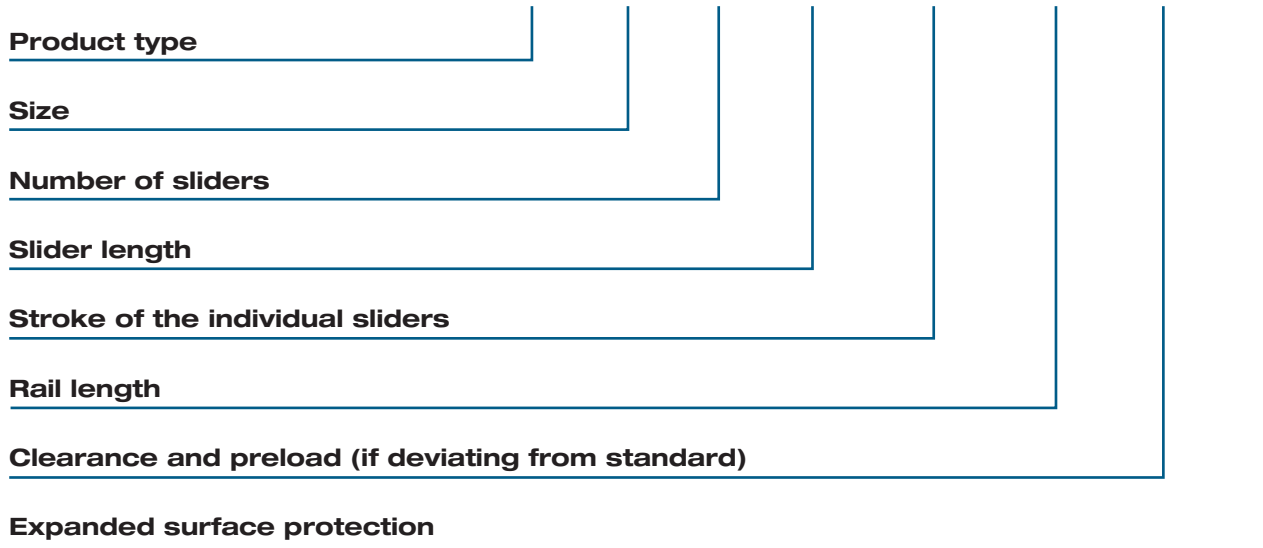

Ordering example 1: SN43-2x290-350-1330

Ordering example 2: SN43-2x290-350-1330-G1-NIC

If the individual slider lengths and/or strokes are different, please order according to ordering example 3.

Ordering example 3: SN28-1x200-300/1x250-415-1240

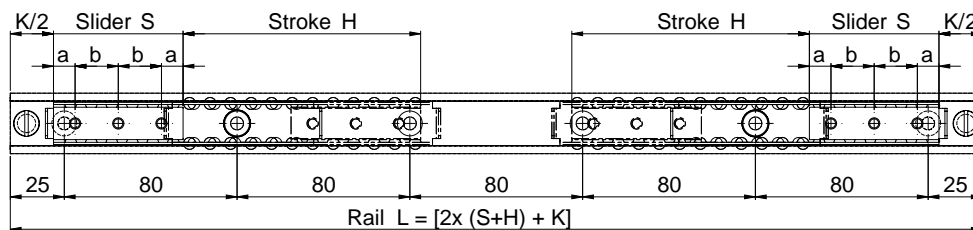

Version 2 is a variant of version 1 with several independent sliders. The total load capacity is based on the number of sliders in the rail and on their lengths. The length and stroke of the individual sliders can be different.

For systems of versions 2 in size 63 with two independent sliders, the K dimension changes from 80 mm to 110 mm and for each additional slider by another 30 mm.

Note: To ensure that all fixing holes of the rail are accessible, S must be $< L/2 - K$. To ensure proper smooth movement it is necessary that $H \leq 7S$

SN Version 3 with Multiple Synchronized Sliders

SN - 63 - 850 - (370+290) - 400 - 1330 - K1 - NIC

Product type	
Size	
Apparent length, S' of the slider	
Individual length of slider	
Stroke	
Rail length	
Clearance and preload (if deviating from standard)	
Expanded surface protection	

Ordering example 1: SN63-850(370+290)-400-1330

Ordering example 2: SN63-850(370+290)-400-1330-K1-NIC

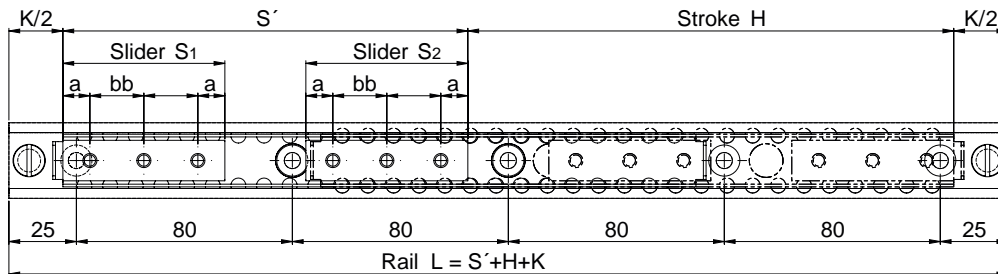

Version 3 is a variant of version 1 with several synchronized sliders. The total load capacity is based on the number of sliders in the rail. The length of the individual sliders can therefore vary.

Note: To ensure that all fixing holes of the rail are accessible, S must be $< L/2 - K$. To ensure proper smooth movement it is necessary that $H \leq 7S$

Technical information

Static Load

The maximum static loads of the SN series are defined using the slider length and are listed in the tables of the previous pages. These load capacities are valid for a loading point of forces and moments in the center of the slider. The load capacities are independent of the position of the slider inside the rails. During the static tests the radial load capacity, C_{0rad} , the axial load capacity, C_{0ax} , and moments M_x , M_y and M_z indicate the maximum permissible values of the loads. Higher loads negatively affect the running properties and the mechanical strength. A safety factor, S_0 , is used to check the static load, which takes into account the basic parameters of the application and is defined in more detail in the following table:

Safety factor S_0

Neither shocks nor vibrations, smooth and low-frequency reverse, high assembly accuracy, no elastic deformations	1 - 1.5
Normal installation conditions	1.5 - 2
Shocks and vibrations, high frequency reverse, significant elastic deformation	2 - 3.5

The ratio of the actual load to maximum permissible load may be as large as the reciprocal of the accepted safety factor, S_0 , at the most.

$$\frac{P_{0rad}}{C_{0rad}} \leq \frac{1}{S_0} \quad \frac{P_{0ax}}{C_{0ax}} \leq \frac{1}{S_0} \quad \frac{M_1}{M_x} \leq \frac{1}{S_0} \quad \frac{M_2}{M_y} \leq \frac{1}{S_0} \quad \frac{M_3}{M_z} \leq \frac{1}{S_0}$$

The formulas above apply for a single load case. If there are two or more of the described forces simultaneously, the following check must be made:

$$\frac{P_{0rad}}{C_{0rad}} + \frac{P_{0ax}}{C_{0ax}} + \frac{M_1}{M_x} + \frac{M_2}{M_y} + \frac{M_3}{M_z} \leq \frac{1}{S_0}$$

- P0rad = effective radial load
- C0rad = permissible radial load
- P0ax = effective axial load
- C0ax = permissible axial load
- M1 = effective moment in the x-direction
- Mx = permissible moment in the x-direction
- M2 = effective moment in the y-direction
- My = permissible moment in the y-direction
- M3 = effective moment in the z-direction
- Mz = permissible moment in the z-direction

Off-center load P of the slider:

For an off-center load of the slider, the different load distribution on the balls must be accounted for with a reduction of the load capacity C. As shown in the diagram below, this reduction of the distance, d, from the loading point is dependent on the slider center. The value, q, is the position factor, the distance, d, is expressed in fractions of slider length S. The permissible load, P, decreases as follows:

$$P = q \cdot C_{0rad} \quad \text{for a radial load}$$

$$P = q \cdot C_{0ax} \quad \text{for an axial load}$$

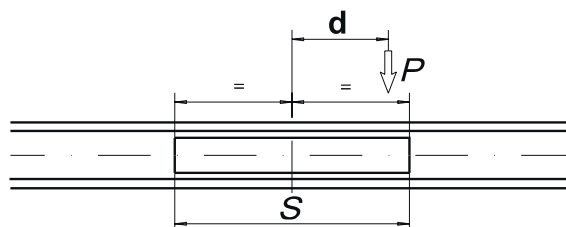

For the static load and the service life calculation, P_{0rad} and P_{0ax} must be replaced by the equivalent values calculated as follows:

$$P_{0rad} = \frac{P}{q} \quad \text{if the external load P acts radially}$$

$$P_{0ax} = \frac{P}{q} \quad \text{if the external load P acts axially}$$

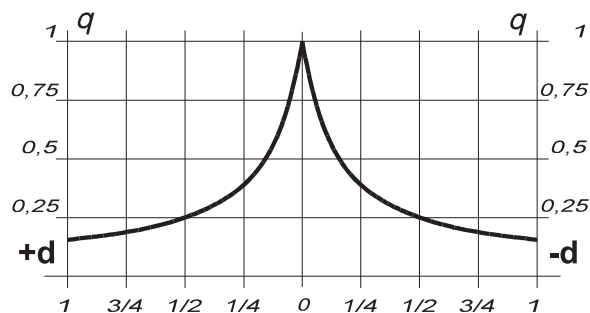

Service Life

The service life of a linear bearing depends on several factors, such as effective load, operating speed, installation precision, occurring impacts and vibrations, operating temperature, ambient conditions and lubrication. The service life is defined as the time span between initial operation and the first fatigue or wear indications on the raceways. In practice, the end of the service life must be defined as the time of bearing decommissioning due to its destruction or extreme wear of a component. This is taken into account by an application coefficient (f_i in the formula below), so the service life consists of:

$$L_{km} = 100 \cdot \left(\frac{C}{W} \cdot \frac{1}{f_i} \right)^3$$

- L_{km} = calculated service life (km)
- C = dynamic load capacity (N) = C_{0rad}
- W = equivalent load (N)
- f_i = application coefficient

The stroke factor f_h takes into account the higher load of the raceways and rollers during short strokes on the same total length of run. The corresponding values are taken from the following graph (for strokes longer than 1 m, f_h = 1):

No. of sliders	1	2	3	4
f _c	1	0.8	0.7	0.63

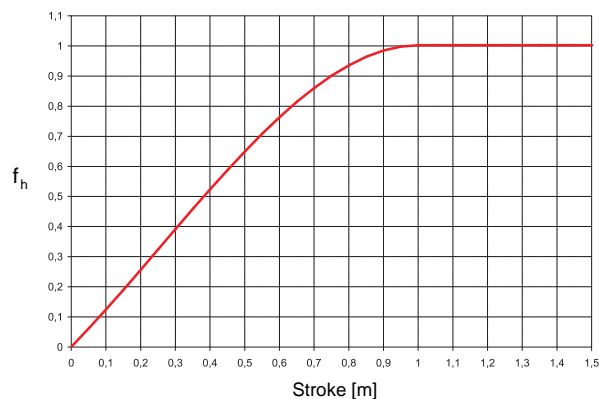

Application coefficient f_i

Neither impacts nor vibrations, smooth and low-frequency direction change, clean operating conditions, low speed (<0.5 m/s)	1 - 1.5
Slight vibrations, average speeds (between 0.5 and 0.7 m/s) and average direction change	1.5 - 2
Impacts and vibrations, high-frequency direction change, high speeds (>0.7 m/s), very dirty environment	2 - 3.5

If the external load, P, is the same as the dynamic load capacity, C_{0rad} , (which of course must never be exceeded), the service life at ideal operating conditions ($f_i = 1$) amounts to 100 km. Naturally, for a single load P, the following applies: $W = P$. If several external loads occur simultaneously, the equivalent load is calculated as follows:

$$W = P_{rad} + \left(\frac{P_{ax}}{C_{0ax}} + \frac{M_1}{M_x} + \frac{M_2}{M_y} + \frac{M_3}{M_z} \right) \cdot C_{0rad}$$

Clearance and Preload

The SN series linear bearings are installed with no clearance as standard. For more information, please contact Rollco.

Preload classes		
Increased clearance	No clearance	Increased preload
G_1	Standard	K_1

Coefficient of Friction

With correct lubrication and installation on level and rigid surfaces and sufficient parallelism for rail pairs, the friction value is less than or equal to 0.01. This value can vary depending on the installation situation.

Linear Accuracy

With installation of the rails using all bolts on a perfectly plane support surface with the fixing holes in a straight line, the linear accuracy of the sliders to an external reference results from the following equation:

$$\parallel = \frac{\sqrt{H}}{300} \text{ (mm)} \quad H = \text{stroke}$$

Speed

The linear bearings of the SN series can be used up to an operating speed of 0.8 m/s (31.5 in/s). With high-frequency direction changes and the resulting high accelerations, as well as with long ball cages, there is a risk of cage creep.

Temperature

The SN series can be used in ambient temperatures from -30 °C to +170 °C (-22 °F to +338 °F). A lithium lubricant for high operating temperatures is recommended for temperatures above +130 °C (+266 °F).

Anticorrosive Protection

The SN series has a standard anticorrosive protection by electrolytic zinc-plating according to ISO 2081. If increased anticorrosive protection is required, the rails are available chemically nickel-plated and with stainless steel bearing balls.

Numerous application-specific surface treatments are available upon request, e.g., as a nickel-plated design with FDA approval for use in the food industry. For more information please contact us.

Lubrication

Recommended lubrication intervals are heavily dependent upon the ambient conditions. Under normal conditions, lubrication is recommended after 100 km operational performance or after an operating period of 6 months. In critical application cases the interval should be shorter. Please clean the raceways carefully before lubrication. Raceways and spaces of the ball cage are lubricated with a lithium lubricant of average consistency (roller bearing lubricant).

Different lubricants for special applications are available upon request. Example: Lubricant with FDA approval for use in the food industry. For more information please contact us.

Fixing screws

The rails of the SN series in sizes 22 to 43 mm are fixed with countersunk head screws according to DIN 7991.

Tightening torques of the standard fixing screws to be used.

Property class	Size	Tightening torque (Nm)
10.9	22	4.3
	28	8.5
	35	14.6
	43	34.7
	63	34.7

Screws for size 63:

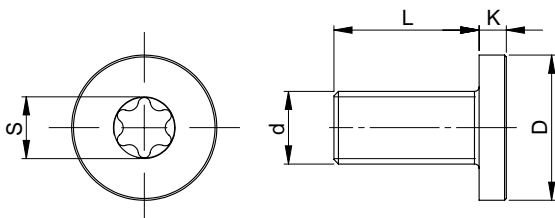

Size	Screw type	d	D	L mm	K	S	Tightening torque
63	M8 x 20	M8 x 1.25	13	20	5	T40	34.7

Installation Instructions

Internal stops are used to stop the unloaded slider and the ball cage. Please use external stops as end stops for a loaded system.

To achieve optimum running properties, high service life and rigidity, it is necessary to fix the linear bearings with all accessible holes on a rigid and level surface.

Prepare a sufficient bevel on the threaded fixing holes, according to the following table:

Size	Bevel (mm)
22	0.5 x 45°
28	1 x 45°
35	1 x 45°
43	1 x 45°
63	1 x 45°

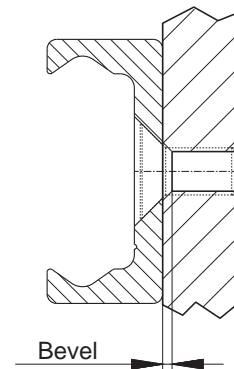

Instructions for Use

For linear bearings of the SN series, the sliders are guided through a ball cage inside the rails. When the sliders run their course relative to the rails, the ball cage moves along for half the slider stroke. The stroke ends as soon as the slider reaches the end of the cage.

Normally the cage moves synchronously to the balls at half the speed of the slider. Any occurring cage slip affects the synchronous movement of the ball cage negatively, causing it to reach the internal stops prematurely (cage creep). This reduces the stroke. However, the stroke value can be normalized at any time by moving the slider to the stop in the stopped cage. This moving of the slider relative to the cage will have increased resistance, which is dependent on the working load.

The causes of cage creep can be installation accuracy, dynamics, and load changes. The effects can be minimized by observing the following advice:

- The stroke should always remain constant and come as close as possible to the nominal stroke of the linear bearing.
- For applications with various strokes, make sure that the drive is sufficiently dimensioned to guarantee a movement of the slider relative to the cage. A coefficient of friction of 0.1 should be calculated for this.
- Another possibility is to include a maximum stroke without load in the working cycle in order to resynchronize the slider and ball cage.

Parallelism errors or inaccuracies in the installation or in the mounting surfaces of mounted pairs can influence the cage creep.

Series SN linear bearings should only be used for horizontal movement.

SN Standard Configurations

The most commonly used standard configurations are shown in the tables. Other deviating configurations and customer-specific adaptations are possible. For more information please contact us.

Size 22

Ordering description	Slider	Stroke	Rail
SN22-40-60-130	40	60	130
SN22-40-140-210	40	140	210
SN22-40-220-290	40	220	290
SN22-60-40-130	60	40	130
SN22-60-120-210	60	120	210
SN22-60-200-290	60	200	290
SN22-60-280-370	60	280	370
SN22-60-360-450	60	360	450
SN22-80-100-210	80	100	210
SN22-80-180-290	80	180	290
SN22-80-260-370	80	260	370
SN22-80-340-450	80	340	450
SN22-80-420-530	80	420	530
SN22-80-500-610	80	500	610
SN22-130-130-290	130	130	290
SN22-130-210-370	130	210	370
SN22-130-290-450	130	290	450
SN22-130-370-530	130	370	530
SN22-130-450-610	130	450	610
SN22-130-530-690	130	530	690
SN22-130-610-770	130	610	770
SN22-130-690-850	130	690	850
SN22-130-770-930	130	770	930
SN22-130-850-1010	130	850	1010
SN22-210-210-450	210	210	450
SN22-210-290-530	210	290	530
SN22-210-370-610	210	370	610
SN22-210-450-690	210	450	690
SN22-210-530-770	210	530	770
SN22-210-610-850	210	610	850
SN22-210-690-930	210	690	930
SN22-210-770-1010	210	770	1010
SN22-210-930-1170	210	930	1170
SN22-290-290-610	290	290	610
SN22-290-370-690	290	370	690
SN22-290-450-770	290	450	770
SN22-290-530-850	290	530	850
SN22-290-610-930	290	610	930
SN22-290-690-1010	290	690	1010
SN22-290-850-1170	290	850	1170

Size 28

Ordering description	Slider	Stroke	Rail
SN28-60-30-130	60	30	130
SN28-60-110-210	60	110	210
SN28-60-190-290	60	190	290
SN28-60-270-370	60	270	370
SN28-60-350-450	60	350	450
SN28-80-90-210	80	90	210
SN28-80-170-290	80	170	290
SN28-80-250-370	80	250	370
SN28-80-330-450	80	330	450
SN28-80-410-530	80	410	530
SN28-80-490-610	80	490	610
SN28-130-120-290	130	120	290
SN28-130-200-370	130	200	370
SN28-130-280-450	130	280	450
SN28-130-360-530	130	360	530
SN28-130-440-610	130	440	610
SN28-130-520-690	130	520	690
SN28-130-600-770	130	600	770
SN28-130-680-850	130	680	850
SN28-130-760-930	130	760	930
SN28-130-840-1010	130	840	1010
SN28-210-200-450	210	200	450
SN28-210-280-530	210	280	530
SN28-210-360-610	210	360	610
SN28-210-440-690	210	440	690
SN28-210-520-770	210	520	770
SN28-210-600-850	210	600	850
SN28-210-680-930	210	680	930
SN28-210-760-1010	210	760	1010
SN28-210-920-1170	210	920	1170
SN28-210-1080-1330	210	1080	1330
SN28-290-280-610	290	280	610
SN28-290-360-690	290	360	690
SN28-290-440-770	290	440	770
SN28-290-520-850	290	520	850
SN28-290-600-930	290	600	930
SN28-290-680-1010	290	680	1010
SN28-290-840-1170	290	840	1170
SN28-290-1000-1330	290	1000	1330
SN28-290-1160-1490	290	1160	1490
SN28-370-360-770	370	360	770
SN28-370-440-850	370	440	850
SN28-370-520-930	370	520	930

Ordering description	Slider	Stroke	Rail
SN28-370-600-1010	370	600	1010
SN28-370-760-1170	370	760	1170
SN28-370-920-1330	370	920	1330
SN28-370-1080-1490	370	1080	1490
SN28-450-440-930	450	440	930
SN28-450-520-1010	450	520	1010
SN28-450-680-1170	450	680	1170
SN28-450-840-1330	450	840	1330
SN28-450-1000-1490	450	1000	1490
SN28-450-1160-1650	450	1160	1650

Size 35

Ordering description	Slider	Stroke	Rail
SN35-130-110-290	130	110	290
SN35-130-190-370	130	190	370
SN35-130-270-450	130	270	450
SN35-130-350-530	130	350	530
SN35-130-430-610	130	430	610
SN35-130-510-690	130	510	690
SN35-130-590-770	130	590	770
SN35-130-670-850	130	670	850
SN35-130-750-930	130	750	930
SN35-130-830-1010	130	830	1010
SN35-210-190-450	210	190	450
SN35-210-270-530	210	270	530
SN35-210-350-610	210	350	610
SN35-210-430-690	210	430	690
SN35-210-510-770	210	510	770
SN35-210-590-850	210	590	850
SN35-210-670-930	210	670	930
SN35-210-750-1010	210	750	1010
SN35-210-910-1170	210	910	1170
SN35-210-1070-1330	210	1070	1330
SN35-210-1230-1490	210	1230	1490
SN35-290-270-610	290	270	610
SN35-290-350-690	290	350	690
SN35-290-430-770	290	430	770
SN35-290-510-850	290	510	850
SN35-290-590-930	290	590	930
SN35-290-670-1010	290	670	1010
SN35-290-830-1170	290	830	1170
SN35-290-990-1330	290	990	1330
SN35-290-1150-1490	290	1150	1490
SN35-290-1310-1650	290	1310	1650
SN35-370-350-770	370	350	770
SN35-370-430-850	370	430	850
SN35-370-510-930	370	510	930
SN35-370-590-1010	370	590	1010

Ordering description	Slider	Stroke	Rail
SN35-370-750-1170	370	750	1170
SN35-370-910-1330	370	910	1330
SN35-370-1070-1490	370	1070	1490
SN35-370-1230-1650	370	1230	1650
SN35-450-430-930	450	430	930
SN35-450-510-1010	450	510	1010
SN35-450-670-1170	450	670	1170
SN35-450-830-1330	450	830	1330
SN35-450-990-1490	450	990	1490
SN35-450-1150-1650	450	1150	1650
SN35-450-1310-1810	450	1310	1810
SN35-530-590-1170	530	590	1170
SN35-530-750-1330	530	750	1330
SN35-530-910-1490	530	910	1490
SN35-530-1070-1650	530	1070	1650
SN35-530-1230-1810	530	1230	1810
SN35-610-670-1330	610	670	1330
SN35-610-830-1490	610	830	1490
SN35-610-990-1650	610	990	1650
SN35-610-1150-1810	610	1150	1810

Size 43

Ordering description	Slider	Stroke	Rail
SN43-130-110-290	130	110	290
SN43-130-190-370	130	190	370
SN43-130-270-450	130	270	450
SN43-130-350-530	130	350	530
SN43-130-430-610	130	430	610
SN43-130-510-690	130	510	690
SN43-130-590-770	130	590	770
SN43-130-670-850	130	670	850
SN43-130-750-930	130	750	930
SN43-130-830-1010	130	830	1010
SN43-210-190-450	210	190	450
SN43-210-270-530	210	270	530
SN43-210-350-610	210	350	610
SN43-210-430-690	210	430	690
SN43-210-510-770	210	510	770
SN43-210-590-850	210	590	850
SN43-210-670-930	210	670	930
SN43-210-750-1010	210	750	1010
SN43-210-910-1170	210	910	1170
SN43-210-1070-1330	210	1070	1330
SN43-210-1230-1490	210	1230	1490
SN43-210-1390-1650	210	1390	1650
SN43-290-270-610	290	270	610
SN43-290-350-690	290	350	690
SN43-290-430-770	290	430	770

STANDARD CONFIGURATIONS

Ordering description	Slider	Stroke	Rail
SN43-290-510-850	290	510	850
SN43-290-590-930	290	590	930
SN43-290-670-1010	290	670	1010
SN43-290-830-1170	290	830	1170
SN43-290-990-1330	290	990	1330
SN43-290-1150-1490	290	1150	1490
SN43-290-1310-1650	290	1310	1650
SN43-290-1470-1810	290	1470	1810
SN43-370-350-770	370	350	770
SN43-370-430-850	370	430	850
SN43-370-510-930	370	510	930
SN43-370-590-1010	370	590	1010
SN43-370-750-1170	370	750	1170
SN43-370-910-1330	370	910	1330
SN43-370-1070-1490	370	1070	1490
SN43-370-1230-1650	370	1230	1650
SN43-370-1390-1810	370	1390	1810
SN43-450-430-930	450	430	930
SN43-450-510-1010	450	510	1010
SN43-450-670-1170	450	670	1170
SN43-450-830-1330	450	830	1330
SN43-450-990-1490	450	990	1490
SN43-450-1150-1650	450	1150	1650
SN43-450-1310-1810	450	1310	1810
SN43-450-1470-1970	450	1470	1970
SN43-530-590-1170	530	590	1170
SN43-530-750-1330	530	750	1330
SN43-530-910-1490	530	910	1490
SN43-530-1070-1650	530	1070	1650
SN43-530-1230-1810	530	1230	1810
SN43-530-1390-1970	530	1390	1970
SN43-610-670-1330	610	670	1330
SN43-610-830-1490	610	830	1490
SN43-610-990-1650	610	990	1650
SN43-610-1150-1810	610	1150	1810
SN43-610-1310-1970	610	1310	1970

Size 63

Ordering description	Slider	Stroke	Rail
SN63-130-400-610	130	400	610
SN63-130-480-690	130	480	690
SN63-130-560-770	130	560	770
SN63-130-640-850	130	640	850
SN63-130-720-930	130	720	930
SN63-130-800-1010	130	800	1010
SN63-210-320-610	210	320	610
SN63-210-400-690	210	400	690
SN63-210-480-770	210	480	770

Ordering description	Slider	Stroke	Rail
SN63-210-560-850	210	560	850
SN63-210-640-930	210	640	930
SN63-210-720-1010	210	720	1010
SN63-210-880-1170	210	880	1170
SN63-210-1040-1330	210	1040	1330
SN63-210-1200-1490	210	1200	1490
SN63-210-1360-1650	210	1360	1650
SN63-290-240-610	290	240	610
SN63-290-320-690	290	320	690
SN63-290-400-770	290	400	770
SN63-290-480-850	290	480	850
SN63-290-560-930	290	560	930
SN63-290-640-1010	290	640	1010
SN63-290-800-1170	290	800	1170
SN63-290-960-1330	290	960	1330
SN63-290-1120-1490	290	1120	1490
SN63-290-1280-1650	290	1280	1650
SN63-370-320-770	370	320	770
SN63-370-400-850	370	400	850
SN63-370-480-930	370	480	930
SN63-370-560-1010	370	560	1010
SN63-370-720-1170	370	720	1170
SN63-370-880-1330	370	880	1330
SN63-370-1040-1490	370	1040	1490
SN63-370-1200-1650	370	1200	1650
SN63-370-1360-1810	370	1360	1810
SN63-450-400-930	450	400	930
SN63-450-480-1010	450	480	1010
SN63-450-640-1170	450	640	1170
SN63-450-800-1330	450	800	1330
SN63-450-960-1490	450	960	1490
SN63-450-1120-1650	450	1120	1650
SN63-450-1280-1810	450	1280	1810
SN63-450-560-1170	450	560	1170
SN63-530-560-1170	530	560	1170
SN63-530-720-1330	530	720	1330
SN63-530-880-1490	530	880	1490
SN63-530-1040-1650	530	1040	1650
SN63-530-1200-1810	530	1200	1810
SN63-530-1360-1970	530	1360	1970
SN63-610-640-1330	610	640	1330
SN63-610-800-1490	610	800	1490
SN63-610-960-1650	610	960	1650
SN63-610-1120-1810	610	1120	1810
SN63-610-1280-1970	610	1280	1970

Rollco Products



COMPACT RAIL

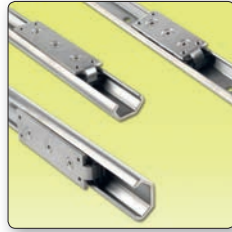

C-RAIL

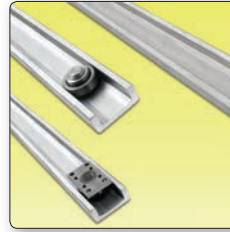

U-RAIL

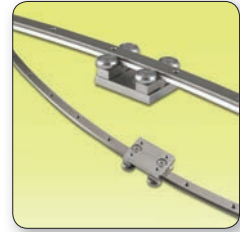

CURVI LINE



LINEAR RAIL SBI



**LINEAR RAIL
BALL CHAIN**



**LINEAR MINIATURE
GUIDE**



**LINEAR ROLLER
GUIDE**

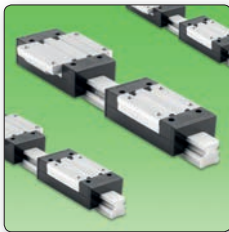

**LINEAR RAIL
ALUMINIUM**



**TELESCOPIC RAIL
HEAVY**



**TELESCOPIC RAIL
LIGHT**

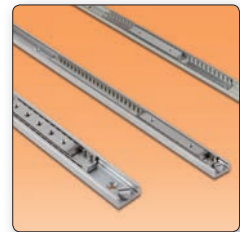

EASYSLIDE

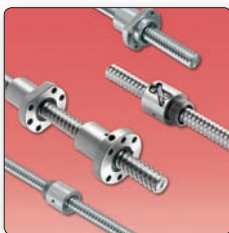

BALL SCREWS

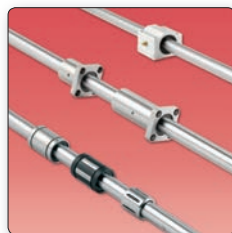

**BALL BEARINGS
& STEEL SHAFTS**



LINEAR UNIT RHL

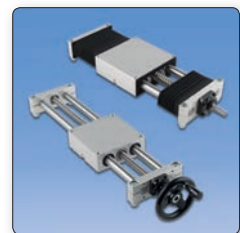

LINEAR UNIT QME



LINEAR UNIT E-SMART



LINEAR UNITS CT & MT



ALUMINIUM PROFILES



BELT CONVEYORS

Rollco AB
Box 22234
Ekvändan 3
250 24 Helsingborg
Sweden
Tel. +46 42 150040
Fax +46 42 150045
www.rollco.se

Rollco A/S
Ladegårdsvej 2
7100 Vejle
Denmark
Tel. +45 7552 2666
Fax +45 7552 0708
www.rollco.dk

Rollco Oy
Sarankulmankatu 12
33900 Tampere
Finland
Tel. +358 207 57 97 90
Fax +358 207 57 97 99
www.rollco.fi

Rollco Norge AS
Industrigata 6
3414 Lierstrada
Norway
Tel. +47 32 84 00 34
Fax +47 32 84 00 91
www.rollco.no

Rollco Taiwan
No. 28, Lane 125, Da-an Road
Shulin District 238
New Taipei City, Taiwan
Tel. +886-2-8687-2726
Fax +886-2-8687-2720
www.rollco-tw.com



ROLLCO
SPECIALIZED
ON LINEAR MOTION