

TB80 Multisystem Timing Belt Conveyor

Multisystem with three up to ten synchronised timing belt conveyors. Options such as cleats, false teeth and coated belt. Stand 100% compatible with conveyor available as an option. Incline or declination of +/- 10° is possible. For dimensions outside our standard range, please contact Rollco.

Note: Please see load/speed diagram for current values. Use our CAD configurator to design your timing belt conveyor according to your preferences and get a visual view, download data sheet and CAD files.



TB40 and TB80 have been extensively tested over its full performance range of speeds, loads, and lengths, together with our standard drive units.

Declaration of installation of partly completed machinery according to Directive 2006/42/EC Annex II 1B.
Dimensions in mm.

Speed (m/min): Up to 54

Drive side: Left/Right

No. of parallel units: Up to 10 pcs

Incline/decline: +/- 10°

System load: Up to 400 kg

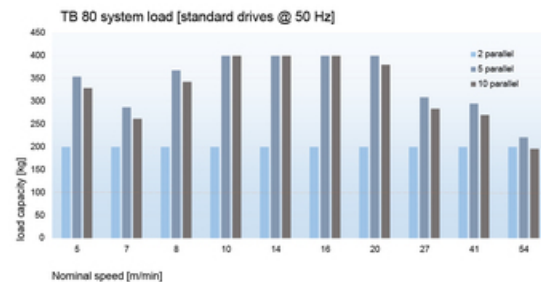
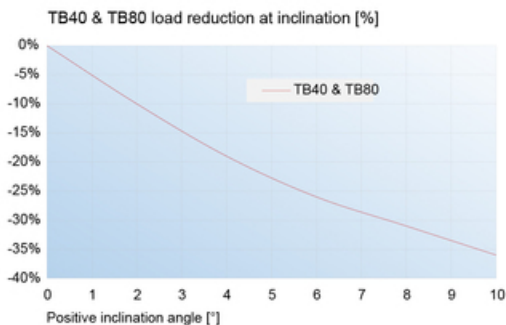

General Data

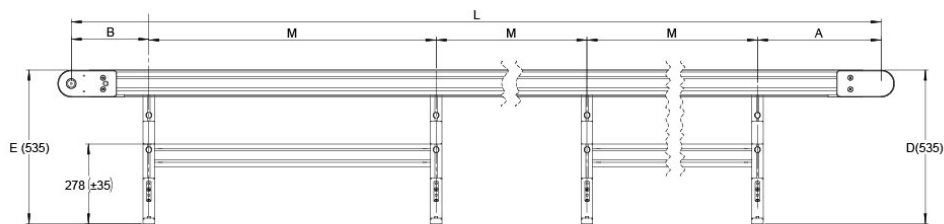
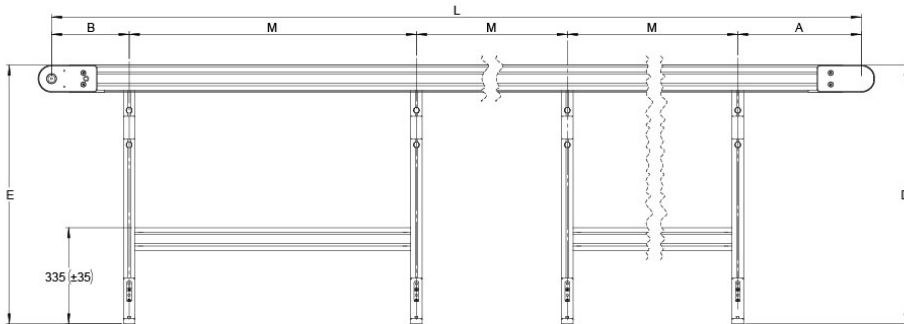
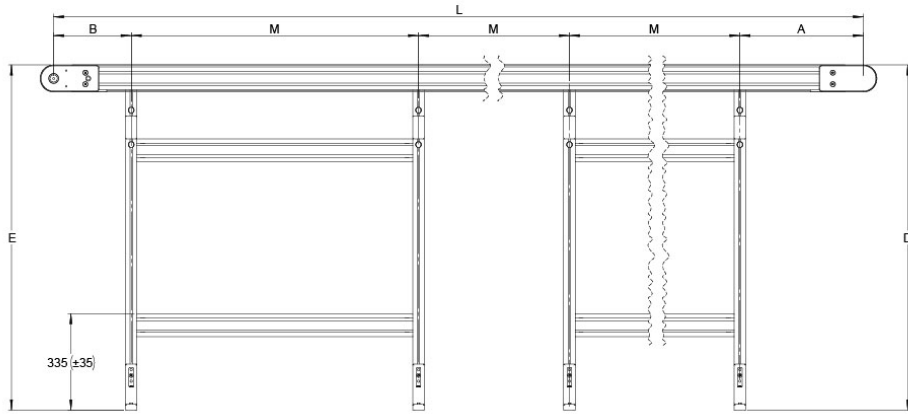

General Data

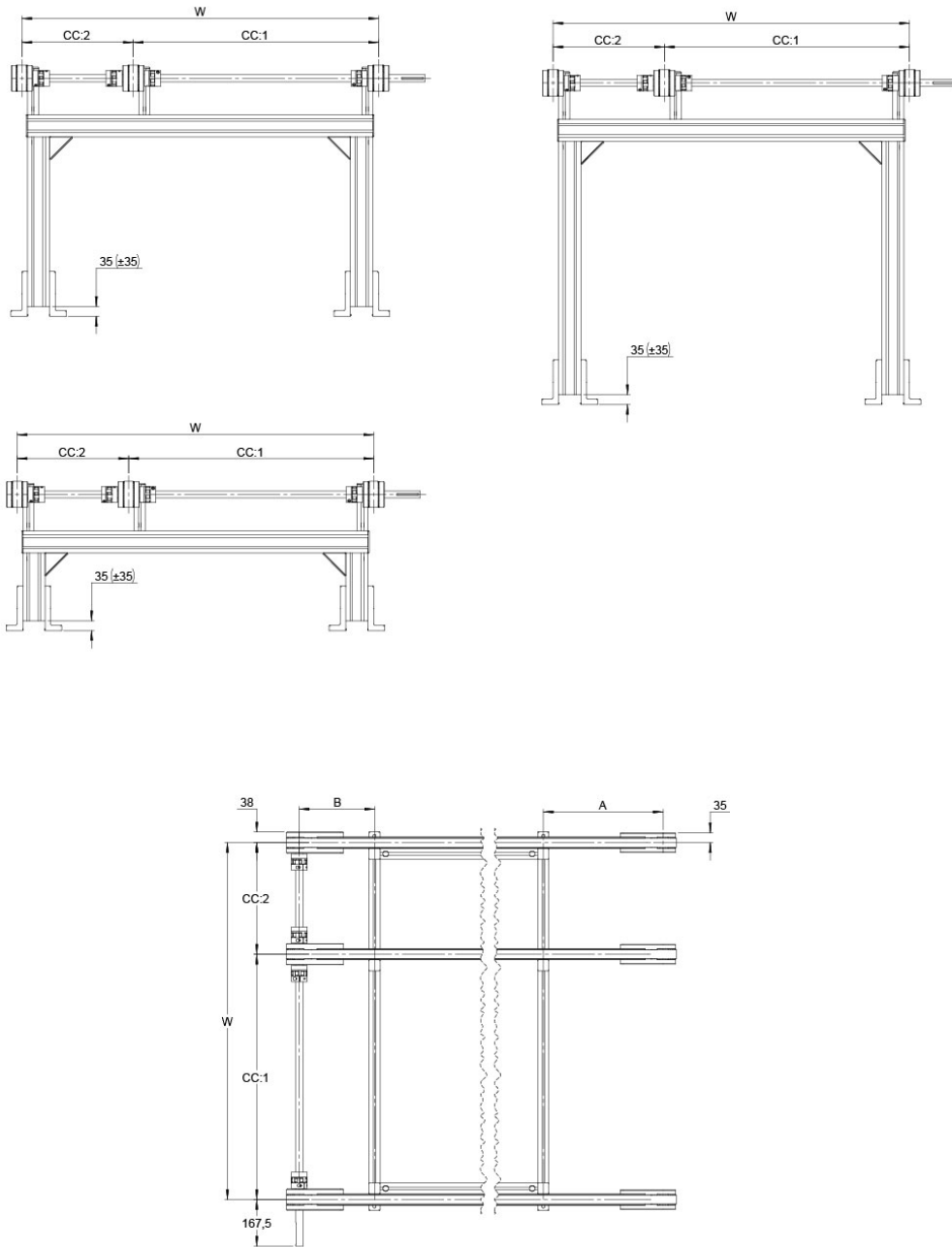

General Data

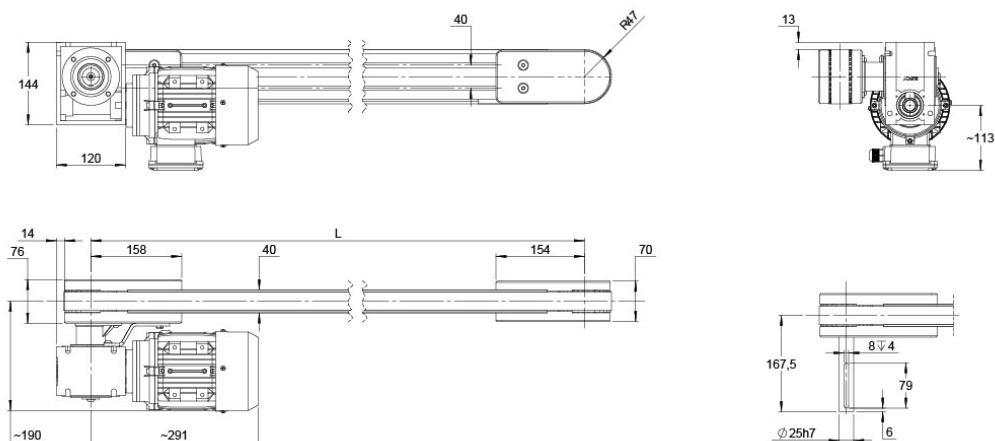

Designation	Profile Width (PW)	Profile Height	Belt Width (BW)	Total Length (L)	Total Width (W)
TB80-multisystem	40	80	32	max 6000	max 6000

Designation	CC	No. of parallell units	A	B	M
TB80-multisystem	max 2000	3-10	210-500	210-250	160-1200