

Magnetic Field Sensors

Contact Rollco for CAD-files.

Dimensions in mm.

Ambient Temperature (°C): -10 ~ +70

Sensor Type: GMR sensor

Switching function: NC/NO

Max. Switching Current (mA): 200x.

Switching Frequency (Hz): 1000

Voltage drop: 1.5 V / 200 mA max.

Protection Class: IP67

Electrical connection: M8, 3-pin

Extension cable: Energy chain compliant

Cable material length: PU - 0.3 m

Output: PNP

Operating Voltage (V DC): 10 ~ 28

Max. Power Rating (W): 5.5 max.

Current consumption: 10 mA / 24 V max.

Shock/vibration: 50 G / 9 G

LED indicator: Yellow



MTJ / MRJ / MTV

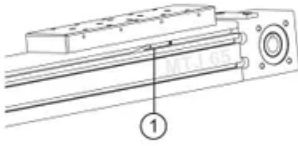

- 1. Magnetic field sensor
- 2. Sensor holder

CTV / CTJ

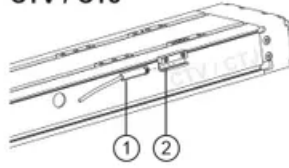





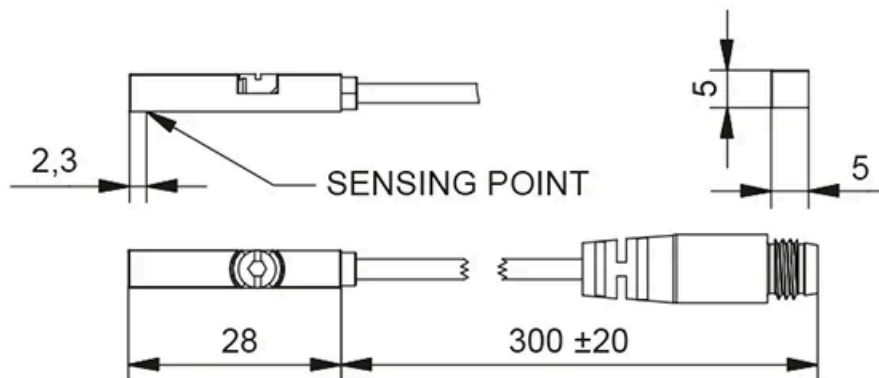



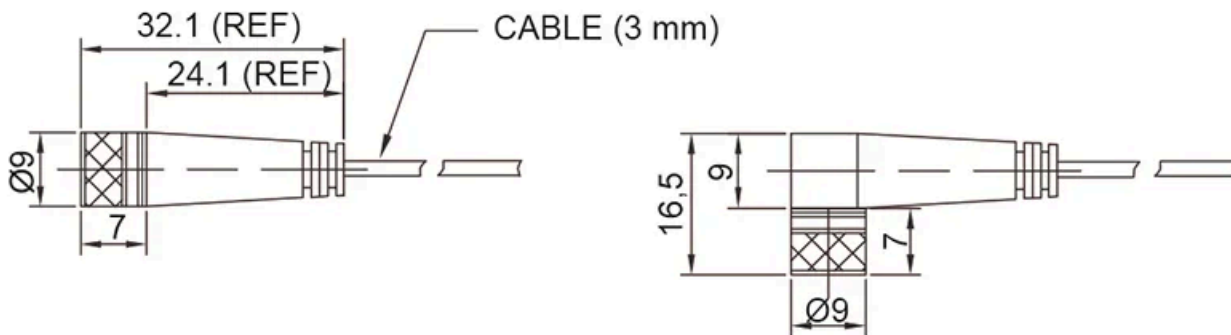

Mounting of magnetic field sensor on CTV and CTJ series requires a HOM sensor holder. For CTV/CTJ 200 a HOM sensor holder is not needed

General Data



Extension cable with connector



Type	Compatibility	
HOM Sensor holder	CTV 90, 110, 145 CTJ: 90, 110, 145	
SMT-65TP-K NC	MTJ / MRJ / MTV / MTJZ: 40, 65, 80, 110 CTV / CTJ: 200	
SMT-65TP-K NC+HOM	CTV 90, 110, 145 CTJ: 90, 110, 145	
SMT-65TP-K NO	MTJ / MRJ / MTV / MTJZ: 40, 65, 80, 110 CTV / CTJ: 200	
SMT-65TP-K NO+HOM	CTV 90, 110, 145 CTJ: 90, 110, 145	
Extension Cable length 2m - Straight connector		
Extension Cable length 5m - Straight connector		
Extension Cable length 2m - Angeled connector		
Extension Cable length 5m - Angeled connector		

Designation	Compatible with
HOM Sensor holder - 43851	CTV 90, 110, 145CTJ: 90, 110, 145
SMT-65TP-K NC - 74073	MTJ / MRJ / MTV / MTJZ:40, 65, 80, 110 CTV / CTJ: 200
SMT-65TP-K NC - 77075	CTV 90, 110, 145CTJ: 90, 110, 145
SMT-65TP-K NO - 74074	MTJ / MRJ / MTV / MTJZ:40, 65, 80, 110 CTV / CTJ: 200
SMT-65TP-K NO - 77076	CTV 90, 110, 145CTJ: 90, 110, 145
Extension Cable length 2m - Straight connector - 8146	-
Extension Cable length 5m - Straight connector - 8147	-
Extension Cable length 2m - Angeled connector - 9017	-
Extension Cable length 5m - Angeled connector - 9019	-